

Quick Reference Card

Understanding the User Interface Keypad

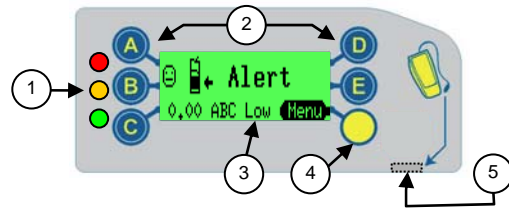

1	3 LEDs	Red, Amber, Green
2	Buttons A to E	Dispense coins & navigate through menus
3	Display (LCD)	Menu information & warning display
4	Mode Button	Access service & set-up menus
5	Service Connector	CPM compatible

General Keypad Button Operation

When the changegiver is in the idle state, the blue buttons can be used to dispense coins from the tubes. If however, the mode button is pressed beforehand, these buttons are used to navigate through the service & set-up menu options.

General Operation of Keypad Buttons			
A	Dispense coin from tube A	D	Dispense coin from tube D
B	Dispense coin from tube B	E	Dispense coin from tube E
C	Dispense coin from tube C	Mode Button	

The mode button can be used to access the two configuration modes available. Service Mode and Set-up mode.

Service Mode: gives access to the most frequently used product configuration options. (See Service Mode Options)

Set-up Mode: gives access to general product configuration options that are required when setting up your changegiver. (See Set-up Mode Options)

Mode Button Operation Functions	
	Press quickly to access Service Mode menus
	Press and Hold for 2 seconds, will access the Set-up Mode menus without a pass code required. Note: If however the changegiver had detected an error/fault, this action will take you to the test/diagnostic menu.
	Access the Set-up Mode menus. You will be prompted for a pass code. Press
	Ensure tube cassette is fitted then press button twice to view changegiver audit data
	Remove tube cassette then press button twice to align all dispenser arms to their home position

Service Mode Options

Press Button Sequence	Description / (Action)
	Float coin tubes / (Insert coins then press button)
	Clear credit accumulated – (Not MDB) & Clear Clean Me message.
	Float teach takes a snapshot of current tube levels.
	Inhibit a coin / (Insert a coin and press reject lever)
	Enable a coin / (Insert a coin then press button)
	View coin details / (press to scroll up & down)
	View channel set / (press to exit view)
	Teach vend price / (Insert coins to the value of the price and then press the price line button on the machine to set it. When finished press button) This feature is only available on Executive products
	Custom tube cassette teach / Enter code and press
	Select predefined tube cassette / (then press reject lever)

LED Light Codes

The 3 LEDs fitted on the changegiver provides up to the minute status information. Please refer to the table below for more details.

	On	Changegiver OK	
	Cycles X 5	Normal power up sequence. Changegiver OK	
	Blinks Off	Coin accepted / rejected (Refer to Green LED Codes)	
	Flashing	Changegiver in Menu mode (Refer to Green LED Codes)	
	On	Changegiver inhibited by VMC	
	Flashing	Changegiver requires attention (Refer to Amber LED Codes)	
	Off	No Power to Changegiver. Check power looms are connected & ensure power is switched ON.	
	Alternating	Changegiver Faulty (Remove from vending machine)	

Green LED Codes

In Idle Condition	General operation LED Code
	Coin tubes are low in change. (Float tubes)
	A message has been left for you to read.

Green LED Codes

After Pressing Mode Button	LED Codes for when in Set-up or Service Mode	
		Slow Flash Changegiver is in Service Mode
		Fast Flash Changegiver is in Set-up Mode and a menu option has been selected

Coin Accepted / Rejected	Coin Discrimination LED Codes	
	1 x Blink	Inserted coin was accepted
	2 x Blinks	Inserted coin was rejected - unknown (not recognised by discriminator)
	3 x Blinks	Coin rejected (Inhibited by machine or changegiver program settings)

Amber LED codes

The amber LED allows you to pinpoint a fault that may have occurred on one of the modules of the changegiver. These types of fault can be rectified at the machine and can be for example caused by; a coin jam, dirt built up or the cassette has been removed etc. The changegiver also indicates on its display which module is being affected.

Amber Flashes	Changegiver Maintenance LED Codes	
1 x	Discriminator error	Alert Reject Lever Menu
2 x	Accept gate error	Alert Accept gate Menu
3 x	Separator module top level sensor Tube cassette error	Alert Cassette out Menu
4 x	Dispenser module error	Alert Dispenser C Menu

Selecting a Predefined Cassette

The changegiver has stored in memory a selection of predefined tube cassettes. Each cassette allows a different payout option to be selected. (See table below). Using the buttons on the keypad, press the button sequence as shown on the table or refer to the tube cassettes front label for the button sequence. Once the changegiver has accepted the code, the chosen cassette will be set.

To select a predefined cassette, Press followed by the button code. Finally press accept to confirm.

Button Code	Tube A	Tube B	Tube C	Tube D	Tube E
AA	1Kr	-	5Kr	-	1Kr
AB	1Kr	10Kr	5Kr	10Kr	1Kr
AC	1Kr	10Kr	5Kr	1Kr	1Kr
AD					
AE					
BA					
BB					
BC					
BD					
BE					
CA					
CB					

Sweden

Accessing the Service Mode Menu

A Quick press of the yellow mode button will take you into the **Service Mode** menus. The display will change to show the options available. (See picture below). Once in this mode the green LED will start to flash. Using the blue buttons, select the option required.

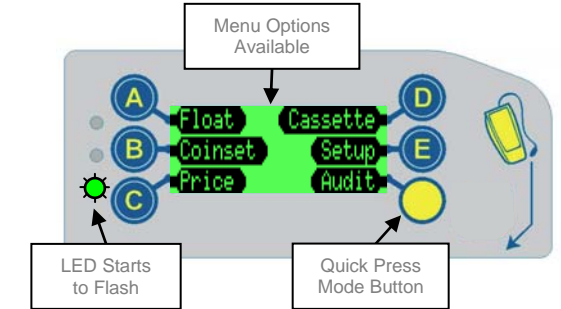

Accessing the Set-up Mode Menu

To access the **Set-up Mode** menus, press the yellow mode button followed by the E button. You will now be prompted to enter the access code. This is achieved by pressing buttons A then B then C.

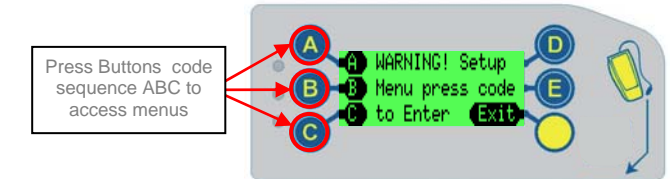

The display will now show the first available option "Prices" Press the blue D button to scroll up one level of the menu. (see picture below).

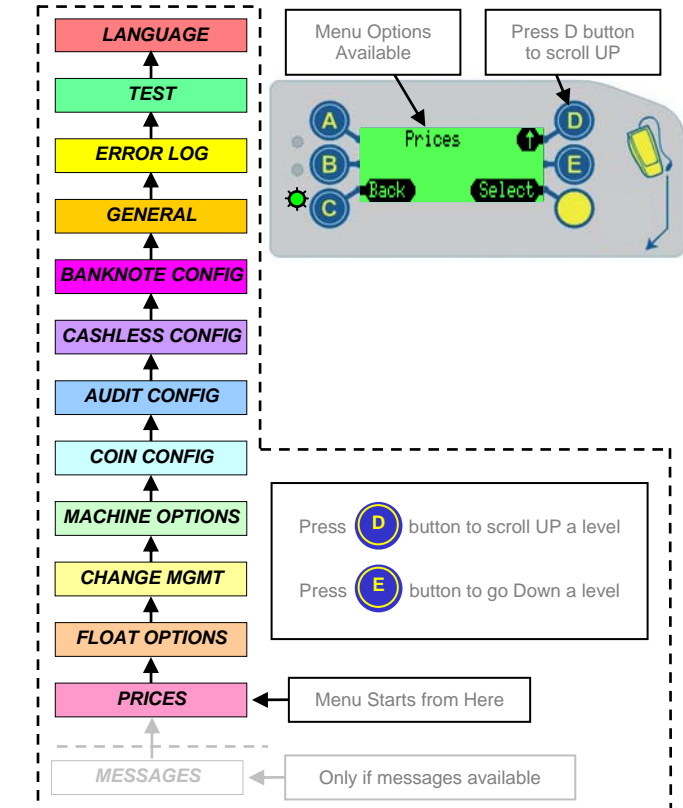

Set-up Mode Menus

This chart shows a detailed structure of the **Set-up** Menus. To access the **Set-up Mode** menus, Press the Yellow button followed by the E button. Enter the access code by pressing buttons **A** then **B** then **C**.

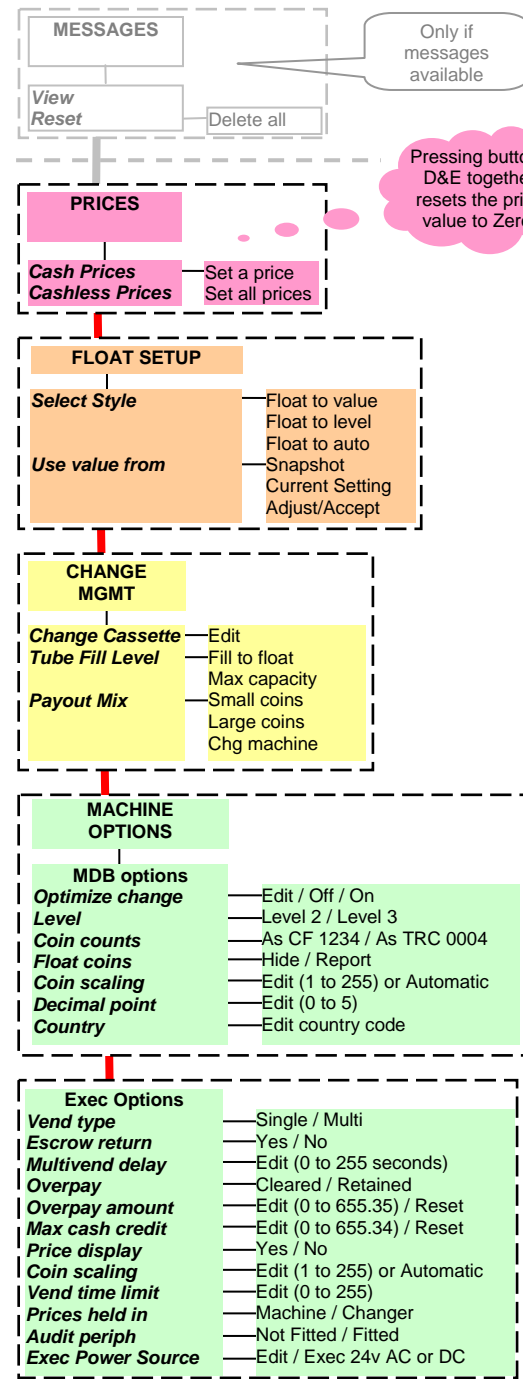

Only if messages available

Pressing buttons D&E together resets the price value to Zero.

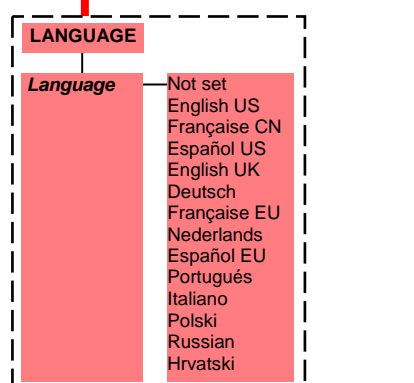
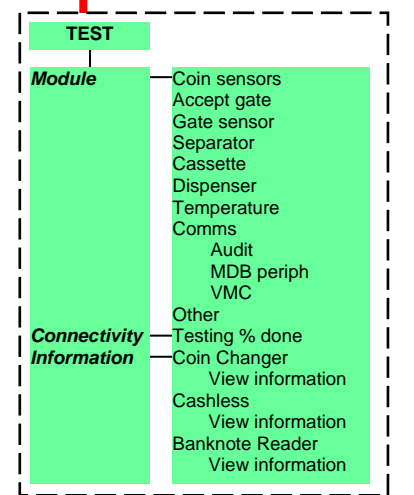
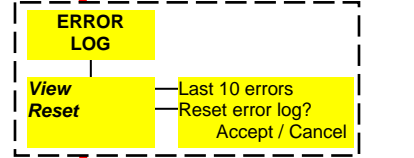
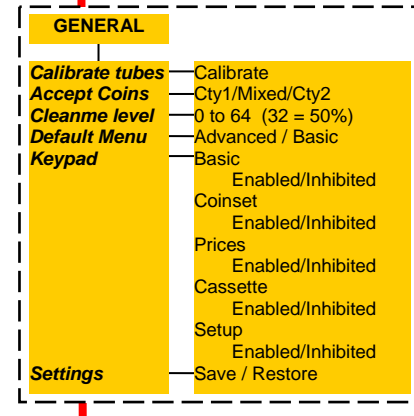
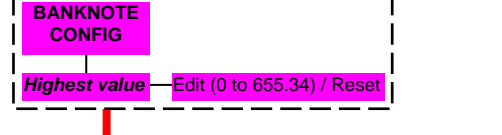
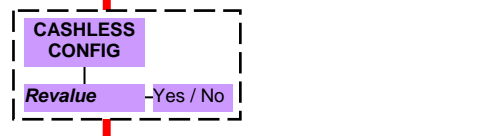
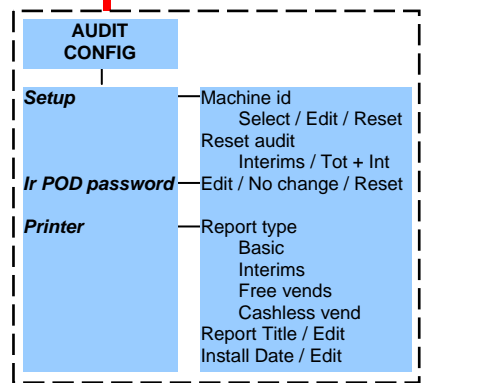
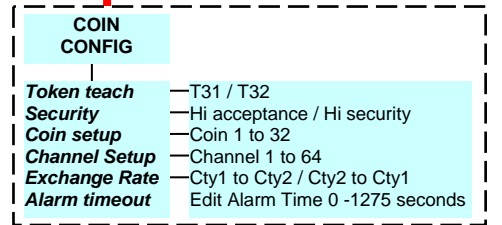
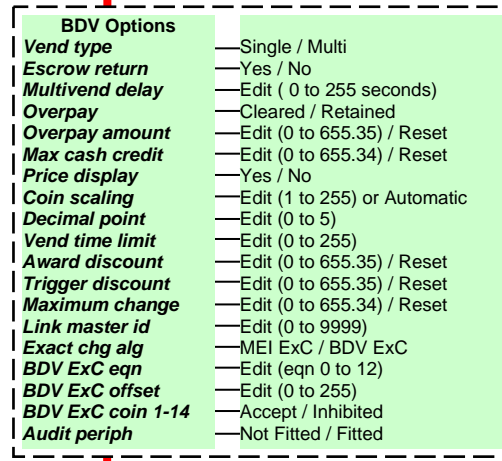

Display - Symbol Indicators

During the changeover programming or normal operation, icons may be shown on the display. These icons will indicate if the changeover requires any attention or will assist you in selecting a particular program mode.

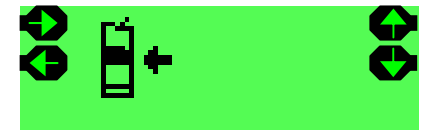

Symbol	Meaning	Comment
	Menu navigation	Move cursor to the right
	Menu navigation	Move cursor to the left
	Menu navigation	Move up through a menu or increase a value setting
	Menu navigation	Move down through a menu or decrease a value setting
	Message waiting*	A message has been left for you to read
	Smiley face	Changegiver is OK
	Average face	Changegiver requires assistance
	Sad face	Changegiver requires replacing
	Maintenance required	Check discriminator for coin jam or dirt
	Maintenance required	Check accept gate for coin jam or dirt
	Maintenance required	Check separator coin level sensors for coin jam or dirt
	Maintenance required	Check dispenser for coin jam or dirt

***Message Waiting Icon:** - If there is a message waiting to be read, the envelope icon will be shown on the display and the green LED will be flashing.

This message is displayed when/if the changeover has detected that it can be optimised for better performance e.g. better tube combinations, payout algorithm etc. thus improving sales.

Reading the Message: Access the setup menu in the normal way (the display will show the word "messages") and follow the instructions on the display. The messages will be displayed in the order of; last in first out. The changeover can store up to four messages at a time, when these have been read, you can delete them by going through to the reset messages menu. The green LED will flash continuously until the messages have been deleted.